



HAL
open science

On line inter-turn short-circuit fault diagnosis and nonlinear control of PMSM

Samir Bouslimani, Said Drid, Larbi Chrifi-Alaoui, Laurant Delahoche

► **To cite this version:**

Samir Bouslimani, Said Drid, Larbi Chrifi-Alaoui, Laurant Delahoche. On line inter-turn short-circuit fault diagnosis and nonlinear control of PMSM. 2022 19th International Multi-Conference on Systems, Signals & Devices (SSD), May 2022, Sétif, Algeria. pp.1139-1143, 10.1109/SSD54932.2022.9955651 . hal-04011979

HAL Id: hal-04011979

<https://u-picardie.hal.science/hal-04011979>

Submitted on 12 Sep 2023

HAL is a multi-disciplinary open access archive for the deposit and dissemination of scientific research documents, whether they are published or not. The documents may come from teaching and research institutions in France or abroad, or from public or private research centers.

L'archive ouverte pluridisciplinaire **HAL**, est destinée au dépôt et à la diffusion de documents scientifiques de niveau recherche, publiés ou non, émanant des établissements d'enseignement et de recherche français ou étrangers, des laboratoires publics ou privés.

On line inter-turn short-circuit fault diagnosis and nonlinear control of PMSM

Samir Bouslimani
Higher National School of Renewable
Energy, Environment and Sustainable
Development, Batna, Algeria
Laboratory LSPIE, Batna, Algeria
s.bouslimani@hns-re2sd.dz

Said Drid
University of Batna 2
Laboratory LSPIE,
Batna, Algeria
saiiddrid@ieeee.org

Larbi Chrifi-Alaoui
Université de Picardie Jules Verne,
Laboratory LTI, Amiens, France
larbi.alaoui@u-picardie.fr

Laurant Delahoche
Université de Picardie Jules Verne,
Laboratory LTI, Amiens, France
laurent.delahoche@u-picardie.fr

Abstract— This paper deals with the detection of inter turn fault in the stator winding of a permanent magnet synchronous motor (PMSM) in closed-loop. The technique proposed to detect the turn-to-turn short circuit faults is based on the parametric estimation and therefore the analysis of the two voltage signals over the resistance R_d and R_q . The proposed approach is tested and the simulation results confirm the effectiveness of the proposed method to detect the turn-to-turn short circuit fault. As it provides the information essential for the fault isolation.

Keywords— permanent magnet synchronous motor (PMSM), condition monitoring, inter turn short circuit, fault diagnosis

I. INTRODUCTION

The stator end winding leakage field of the electrical machines causes the mechanical vibrations of the end winding which generates electrical faults of winding [1]. The stator faults reduce the value of the electromagnetic torque and increase the vibrations, which cause oscillations of the speed, and generates mechanical vibrations. The large amplitude of these oscillations are the main reasons of the machine deterioration. The presence of faults affects the efficiency of the motor drive, so early detection not only reduces repair costs but also energy losses. In electrical machines, one of the most critical faults is the break in the inter-turn insulation in the stator winding, generating a inter turn short circuit. [3]-[4].

To avoid motor failure, it is important to have information on the state of health of the stator winding. The majority of work carried out in the field of system monitoring and diagnostics, the tools used to detect and locate faults are synthesized from an open-loop representation of the system. However, the reality of industrial applications means that systems are generally inserted in a regulation or control loop. Closed loop diagnostics are particularly tricky for a number of reasons. On the one hand, the controller can mitigate the effect of faults which makes their detection difficult.

On the other hand, the system inputs being correlated with the outputs because of the looping, this creates a difficulty for localization. In order to detect the faults, there are two methods: offline testing and online monitoring [5], [6]. The first one requires to stop the machine, while the second does not need to stop the process [7-13].

In this paper, a new diagnostic technique is applied to the PMSM in order to detect the Inter-Turn Short Circuit Fault, this method is based on the parametric estimation of the stator resistance on the d and q axis and therefore the analysis of the voltage drop V_d and V_q . This approach can be used at different levels monitoring and as a tool for online diagnosis.

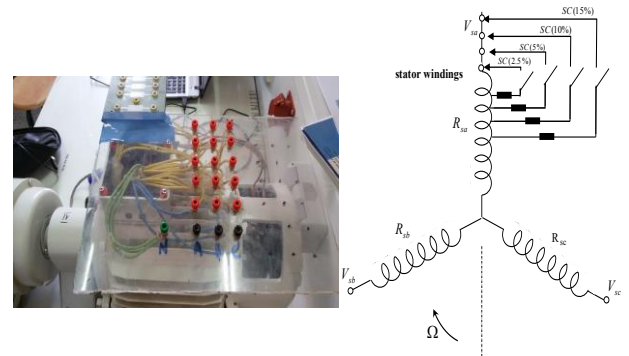

Fig. 1. PMSM stator windings with an inter-turn short circuit faults.

II. PMSM MODELING

The PMSM model in synchronous reference frame is given as follows:

$$\begin{cases} \frac{dI_d}{dt} = -\frac{R_d}{L_d} I_d + \frac{L_q}{L_d} I_q \omega + \frac{v_d}{L_d} \\ \frac{dI_q}{dt} = -\frac{R_q}{L_q} I_q - \frac{L_d}{L_q} I_d \omega + \frac{\phi_f}{L_q} + \frac{v_q}{L_q} \end{cases} \quad (1)$$

Where I_d and I_q are stator currents in rotating reference frame (d q reference frame), R_d , R_q is stator resistances, L_d and L_q are dq reference frame stator inductances, ω is electrical rotor speed, V_d and V_q are stator voltages in d-q reference frame, ϕ_f is permanent magnet flux.

The expression for the electromagnetic torque can be described as:

$$T_e = \frac{3}{2} p [\phi_f I_q - (L_d - L_q) I_d I_q] \quad (2)$$

The dynamic equation of the wind turbine is described by:

$$J \frac{d\Omega}{dt} = T_e - T_m - F \Omega \quad (3)$$

Where J is the moment of inertia, F is the viscous friction coefficient and Tm is the mechanical torque developed by the turbine.

III. A NON-LINEAR CONTROL STRATEGY

With the presence of uncertainties in the studied system and to enhance the overall system performances, a nonlinear Control Based on Lyapunov is proposed for control of PMSM.

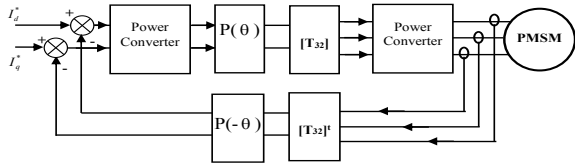

Fig. 2: The diagram block of PMSM control system.

The suggested PMSM control scheme is shown in Fig. 2. We can also note the placement of the estimator block which evaluates the feedback function fd and fq given by:

$$\begin{cases} f_d = -\frac{R_d}{L_d} I_d + \frac{L_q}{L_d} I_q \omega \\ f_q = -\frac{R_q}{L_q} I_q - \frac{L_d}{L_q} \omega I_q + \frac{\phi_f}{L_q} \omega \end{cases} \quad (4)$$

To determine the control feedback, we rewrite (1) as follow

$$\begin{cases} \frac{dI_d}{dt} = \lambda_d v_d + f_d \\ \frac{dI_q}{dt} = \lambda_q v_q + f_q \end{cases} \quad (5)$$

With: $\lambda_d = 1/L_d$ and $\lambda_q = 1/L_q$

The nonlinear functions fd and fq involved in the state-space model (1) are strongly affected by the conventional effects of PMSM.

$$\begin{cases} \frac{dI_d}{dt} = \lambda_d v_d + \hat{f}_d + \Delta f_d \\ \frac{dI_q}{dt} = \lambda_q v_q + \hat{f}_q + \Delta f_q \end{cases} \quad (6)$$

Let the candidate Lyapunov function related to the currents dynamics defined by:

$$V = \frac{1}{2} e_d^2 + \frac{1}{2} e_q^2 > 0 \quad (7)$$

With: $e_d = I_d - I_{d_ref}$ and $e_q = I_q - I_{q_ref}$

This function is globally positive defined over the whole state space. Its derivative is given by

$$\dot{V} = e_d \dot{e}_d + e_q \dot{e}_q \quad (8)$$

Inserting (6) in (8) we obtain:

$$\dot{V} = (\lambda_d v_d + f_d + \Delta f_d - \dot{I}_{d_ref}) e_d + (\lambda_q v_q + f_q + \Delta f_q - \dot{I}_{q_ref}) e_q \quad (9)$$

Selecting the control law as:

$$\begin{cases} v_d = \frac{1}{\lambda_d} (-\dot{f}_d + \dot{I}_{d_ref} - K_1 e_d - K_{11} \text{sgn}(e_d)) \\ v_q = \frac{1}{\lambda_q} (-\dot{f}_q + \dot{I}_{q_ref} - K_2 e_q - K_{22} \text{sgn}(e_q)) \end{cases} \quad (10)$$

Where K_{11} and $K_{22} > \beta i$

New entries must be designed to ensure that:

$$\begin{cases} \lim_{t \rightarrow +\infty} (I_d - I_{d_ref}) = 0 \\ \lim_{t \rightarrow +\infty} (I_q - I_{q_ref}) = 0 \end{cases}$$

Inserting the control law (9) in (10), we obtain:

$$\dot{V}_1 = e_d (\Delta f_d - K_{11} \text{sign}(e_d)) + e_q (\Delta f_q - K_{22} \text{sign}(e_q)) + \dot{V} < 0 \quad (11)$$

Where \dot{V} is given by:

$$\dot{V} = -K_1 e_d^2 - K_2 e_q^2 < 0 \quad (12)$$

The Δf_d and Δf_q variations can be absorbed if we take:

$$\begin{aligned} K_{11} &> |\Delta f_d| \\ K_{22} &> |\Delta f_q| \end{aligned}$$

These inequalities are satisfied if $K_{1,2} > 0$ and $|\Delta f| < \beta < K_{11,22}$

Finally, we can write: $\dot{V}_1 < \dot{V} < 0$

$$\text{and } \begin{cases} \lim_{t \rightarrow +\infty} (I_d - I_{d_ref}) = 0 \\ \lim_{t \rightarrow +\infty} (I_q - I_{q_ref}) = 0 \end{cases}$$

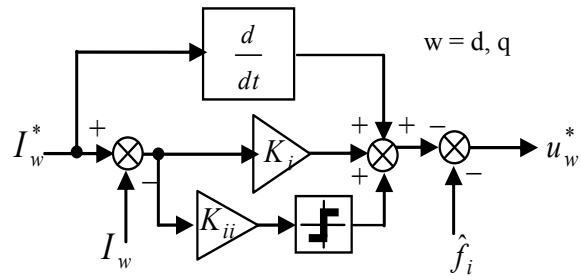

Fig. 3: Robust controller design scheme.

In order to detect the stator faults, we propose this method based on the estimation of the resistances R_d and R_q and therefore analysis of the two signals based ($V_{rd}=R_d.I_d$, $V_{rq}=R_q.I_q$).

The Park and inverse Park transformation are given by equations (13), (14):

$$\begin{bmatrix} I_d \\ I_q \end{bmatrix} = \begin{bmatrix} \cos(\theta) & \cos(\theta - \frac{2\pi}{3}) & \cos(\theta - \frac{4\pi}{3}) \\ -\sin(\theta) & -\sin(\theta - \frac{2\pi}{3}) & -\sin(\theta - \frac{4\pi}{3}) \end{bmatrix} \begin{bmatrix} i_a \\ i_b \\ i_c \end{bmatrix} \quad (13)$$

$$\begin{bmatrix} V_{r\alpha} \\ V_{r\beta} \end{bmatrix} = \begin{bmatrix} \cos(\theta) & -\sin(\theta) \\ \sin(\theta) & \cos(\theta) \end{bmatrix} \begin{bmatrix} V_{rd} \\ V_{rq} \end{bmatrix} \quad (14)$$

A. Observer of Luenberger

The state observer structure is showed in Fig. 4, it is based on the system model.

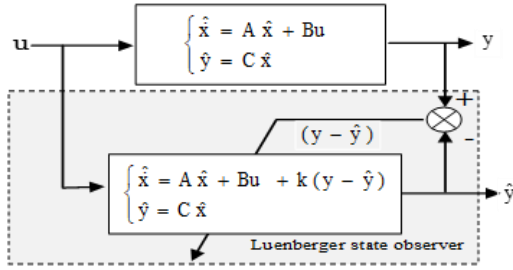

Fig. 4: Block diagram of Luenberger state observer

The feedback error ensures that the observed states do not drift from the real ones. The error states estimation is used to correct the observed states. The observer dynamics error are defined by placing the eigen values of matrix $(A-LC)$.

Usually, pole placement algorithms, such as Ackermann's equation, are used to calculate L [14]. The Luenberger observer is given in (15) and is shown in Fig. 4.

B. Observer design

The Luenberger observer can be expressed by the follow Equations:

$$\begin{cases} \dot{\hat{x}} = A\hat{x} + Bu + k(y - \hat{y}) \\ \hat{y} = C\hat{x} \end{cases} \quad (15)$$

Also, by using (1) we can write

$$\begin{cases} \frac{d\hat{I}_d}{dt} = -\frac{\hat{R}_d}{L_d} \hat{I}_d + \frac{L_q}{L_d} \omega \hat{I}_q + \frac{1}{L_d} V_d + k_d (I_d - \hat{I}_d) \\ \frac{d\hat{I}_q}{dt} = -\frac{\hat{R}_q}{L_q} \hat{I}_q - \omega \frac{L_d}{L_q} \hat{I}_d + \frac{\phi_f}{L_q} \omega + \frac{1}{L_q} V_q + k_q (I_q - \hat{I}_q) \end{cases} \quad (16)$$

where k_d and k_q : gains, and \hat{R}_d, \hat{R}_q : are the estimated values of the resistances. The error equation is given as follows:

$$(\dot{x} - \dot{\hat{x}}) = (A - kC)(x - \hat{x}) + (A - A)\hat{x} \quad (17)$$

Where:

$$\hat{A} = \begin{bmatrix} -\frac{\hat{R}_d}{L_d} & \omega \frac{L_q}{L_d} \\ -\omega \frac{L_d}{L_q} & -\frac{\hat{R}_q}{L_q} \end{bmatrix}$$

Then:

$$(A - \hat{A}) = \begin{bmatrix} \frac{\Delta R_d}{L_d} & 0 \\ 0 & \frac{\Delta R_q}{L_q} \end{bmatrix} \quad (18)$$

C. Stability

Consider the Lyapunov functions is given in (19):

$$V = \frac{1}{2} e^T e + \frac{1}{2} \frac{(\Delta R_d)^2}{\lambda_1} + \frac{1}{2} \frac{(\Delta R_q)^2}{\lambda_2} > 0 \quad (19)$$

where: $\lambda_1, \lambda_2 > 0$.

Therefore, the Lyapunov function derivative of the is given as:

$$\dot{V} = e^T e - \frac{\Delta R_d}{\lambda_1} \frac{d\hat{R}_d}{dt} - \frac{\Delta R_q}{\lambda_2} \frac{d\hat{R}_q}{dt} < 0 \quad (20)$$

Ensuring convergence and stability of the process in closed loop control with observer, we get:

$$(A - kC) < 0$$

Finally, we have:

$$\begin{cases} \hat{R}_d = -\frac{\lambda_1}{L_d} \int e_d \hat{I}_d dt \\ \hat{R}_q = -\frac{\lambda_2}{L_q} \int e_q \hat{I}_q dt \end{cases} \quad (21)$$

After the estimation of the two resistances R_d and R_q with the use of the Luenberger observer, so we can plot and analyze the two vectors V_{rd} and V_{rq} through spectral analysis: Fig. 5.

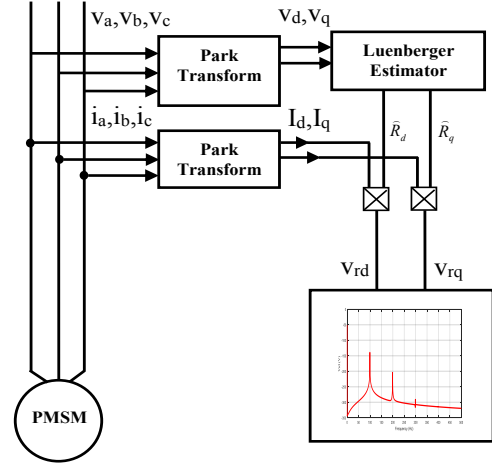

Fig. 5: The proposed approach for Stator Winding inter turn Short-Circuit Fault of PMSM in closed loop.

V. SIMULATION RESULTS

This paper proposes a novel approach diagnostic method for permanent-magnet synchronous motor in closed loop. The simulation results: Fig. 6 and 7 confirm the difficulty of detecting the fault in a closed loop (absence of Harmonics signifying the presence of fault) since the regulator attenuates the effect of fault. On the other hand in Figs. 8, 9, 10 and 11 the spectral analysis of the vectors $V_{rd} = I_d$ and $V_{rq} = I_q$, shows the appearance of the Harmonics at $2.f_S$ of the Park vector of the stator currents under fault (inter-turn short-circuit) conditions.

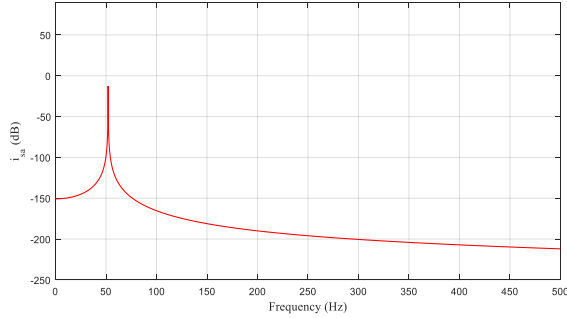

Fig. 6: Spectrum of current vector of phase (a) in healthy PMSM.

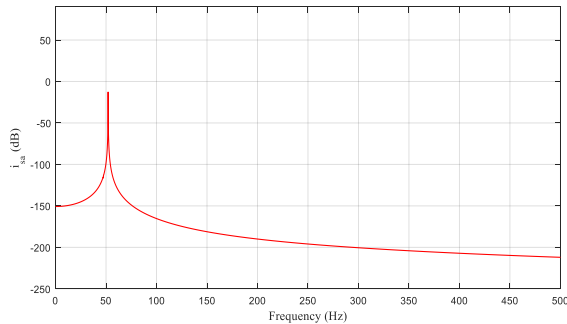

Fig. 7: Spectrum of current vector of phase (a), during the short circuit of phase (a), (2,5%)

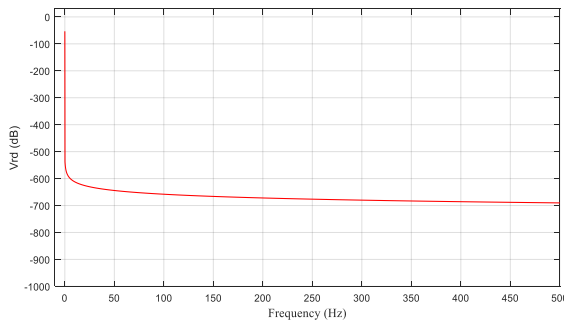

Fig. 8: Spectrum of $V_{rd}=R_d I_d$ in healthy PMSM.

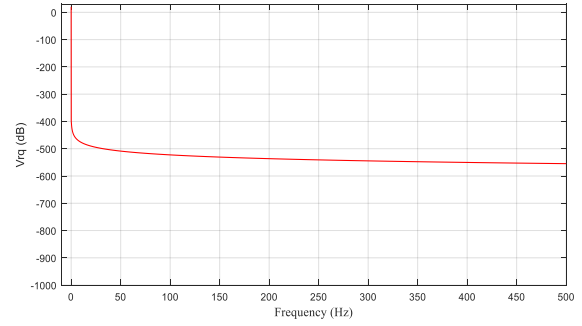

Fig. 9: Spectrum of $V_{rq}=R_q I_q$ in healthy PMSM.

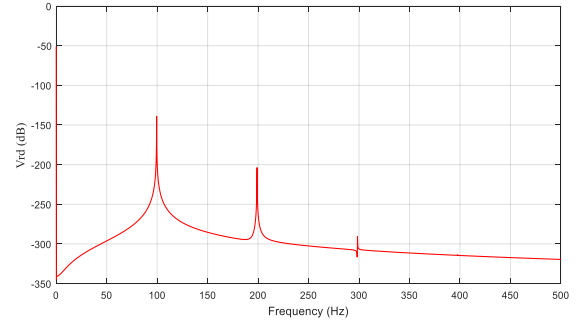

Fig. 10: Spectrum of $V_{rd}=R_d I_d$ during the short circuit (2,5%).

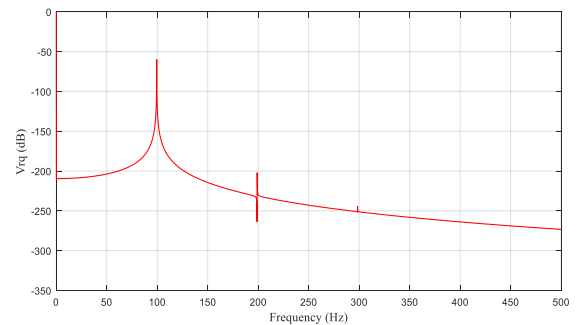

Fig. 11: Spectrum of $V_{rq}=R_q I_q$ during the short circuit (2,5%).

VI. CONCLUSION

In certain industrial sectors and transport systems, breakdowns of electric motors are not acceptable and conditional preventive maintenance must be implemented in order to minimize repair downtime. It is therefore essential to develop new techniques for detecting faults in a closed loop. In this paper, an original approach is proposed, it concern on-line detection the PMSM stator shorted turn faults, by using the parametric estimation and therefore the analysis of the two voltage signals over the resistance R_d and R_q . We have shown that the fault can be detected on the basis of a spectrum analysis. This approach is based on the stator current, which is measurable state and is used in closed loop. The proposed technique has been validated using simulation results.

REFERENCES

- [1] D. Shally, M. Farrell, and K. Sullivan, "Generator end winding vibration monitoring," 43rd International Universities Power Engineering Conference, pp. 1–5, Sept. 2008.
- [2] R. Lin, A. N. Laiho, A. Haavisto, A. Arkkio, "End winding vibrations caused by steady state magnetic forces in an induction machine", IEEE Transactions on Magnetics, Vol. 46, No. 7, pp. 2665-2674, July 2010.
- [3] J. Penman, H.G. Sedding, Al Lloyd, W.T Fink, "Detection and localization of inter turn short circuits in the stator windings of operation motors"ex, IEEE Transactions on Energy Conversion, Vol. 9, No. 4, pp. 652-658, Dec. 1994.
- [4] C. S. Kallesoe, P. Vadstrup, H. Rasmussen, R. Izadi-Zamanabadi, "Estimation of stator winding faults in induction motors using an adaptive observer scheme", IEEE Industry Applications conference, Vol. 2, pp. 1225-1232, Oct. 2004.
- [5] S. Grubic, J. M. Aller, B. Lu, T. G. Habetler, "A survey on testing and monitoring methods for stator insulation systems of low-voltage induction machines focusing on turn insulation Problems", IEEE Transactions on Industrial Electronics, Vol. 55, No. 12, Dec. 2008.
- [6] G. C. Stone, E. A. Boulter, I. Culbert, and H. Dhirani, "Electrical insulation for rotating machines: design, evaluation, aging, testing, and repair", IEEE Press on Power Engineering, pp; 1-69, Jan. 2004.
- [7] W. T. Thomson, "On-line MCSA to diagnose shorted turns in low voltage stator windings of 3-phase induction motors prior to failure", IEEE International Electric Machines and Drives Conference, pp. 891 - 898, June 2001.
- [8] G. B. Kliman, W. J. Premerlani, B. Yazici, R. A. Koegl, J. Mazereeuw, "Sensorless, online motor diagnostics", IEEE Computer Applications in Power, Vol.10, No. 2, pp. 39-43, Apr. 1997.
- [9] J. H. Jung, J. J. Lee, B. H. Know, "Online diagnosis of induction motors using MCSA", IEEE Transactions on Industrial Electronics, Vol. 53, No. 6, pp. 1842-1852, Dec. 2006.
- [10] S. Bouslimani, S. Drid and L. Chrifi -Alaoui, (2014) 'A Extended Park's Vector Approach to Detect Broken Bars Faults in Induction Motor', the 15th International conference on Sciences and Techniques of Automatic control & computer engineering December 21-23, STA'2014, Hammamet, Tunisia.
- [11] S. Bouslimani, S. Drid and L. Chrifi- Alaoui, Pascal Bussy and Mohamed Hamzaoui, (2016) 'Inter-Turn Faults Detection using Park Vector Strategy', the 17th International conference on Sciences and Techniques of Automatic control & computer engineering December 18-21, 2016, STA'2016, Sousse, Tunisia.
- [12] S. Bouslimani, S. Drid and L. Chrifi-Alaoui, " An Extended Park's Vector Approach For The Detection Of Inter-Turn Faults In Induction Motor" International Conference on Automatic Control, Telecommunications and Signals (ICATS'15), Badji Mokhtar Annaba University, 16-18 November, 2015.
- [13] S. BOUSLIMANI, S. DRID et L. CHRIFI-ALAOUI, " Sensorless Control and Diagnosis of Synchronous-Generator used in Wind Energy Conversion System Under Inter Turn Short-Circuit Fault", International Journal of Power and Energy Conversion, IJPEC V 10 No. 4, DOI 10.1504/IJPEC.2019.10012581.
- [14] J. Lunze, (2005) Regelungstechnik 2. New York: Springer-Verlag, 2005.