



HAL
open science

Management and Control of Hybrid System WIND-PV Systems Integrated to the VSC-HVDC Grid

Hamza Sahraoui, Hacene Mellah, Amar Maafa, Abdelghani Yahiou, Said Drid, L. Chrifi-Alaoui

► **To cite this version:**

Hamza Sahraoui, Hacene Mellah, Amar Maafa, Abdelghani Yahiou, Said Drid, et al.. Management and Control of Hybrid System WIND-PV Systems Integrated to the VSC-HVDC Grid. The Eurasia Proceedings of Science Technology Engineering and Mathematics, 2023, 26, pp.430-438. 10.55549/ep-stem.1411057 . hal-04525096

HAL Id: hal-04525096

<https://u-picardie.hal.science/hal-04525096v1>

Submitted on 3 Dec 2024

HAL is a multi-disciplinary open access archive for the deposit and dissemination of scientific research documents, whether they are published or not. The documents may come from teaching and research institutions in France or abroad, or from public or private research centers.

L'archive ouverte pluridisciplinaire **HAL**, est destinée au dépôt et à la diffusion de documents scientifiques de niveau recherche, publiés ou non, émanant des établissements d'enseignement et de recherche français ou étrangers, des laboratoires publics ou privés.



Distributed under a Creative Commons Attribution - NonCommercial 4.0 International License

The Eurasia Proceedings of Science, Technology, Engineering & Mathematics (EPSTEM), 2023

Volume 26, Pages 430-438

ICoNTES 2023: International Conference on Technology, Engineering and Science

Management and Control of Hybrid System WIND-PV Systems Integrated to the VSC-HVDC Grid

Hamza Sahraoui

University of Chlef

Hacene Mellah

University of Bouira

Amar Maafa

University of Bouira

Abdelghani Yahiou

University of Bouira

Said Drid

Higher National School of Renewable Energies

L. Chrifi-Alaoui

University of Picardie

Abstract: The harvesting of natural resources that can be replenished is experiencing explosive growth not just in industrialized nations but also in some less developed nations. This study focuses on the control of a hybrid photovoltaic-wind energy system known as WIND-PV. This system is utilized to serve a load in a city that is not connected to the grid. The type of energy system that was investigated in this study is a hybrid one. It consists of two renewable energy sources—wind and photovoltaic—that are coupled with static converters for the purpose of adaptation and conversion of the forms of electrical energy that may be applied to an isolated metropolis. The modeling of a hybrid PV-WIND system is the most important component of the study that we are doing. We worked on a work plan, which was integrated into a Voltage Source Continuous High-Voltage Direct Current (VSC-HVDC), and this helped us a great deal to have well-determined signals.

Keywords: Wind energy, Renewable energy, Photovoltaic energy

Introduction

The use of renewable energies is not new. These have been exploited by man since the dawn of time. In the past, watermills, windmills, firewood, animal traction, sailing boats have largely contributed to the development of humanity. They constituted an economic activity in their own right, especially in rural areas where they were as important and as diversified as food production.

For this, renewable energies appear today and in the long term as the appropriate solution that covers this energy need by reducing the major inconvenience emitted by fossil fuels since a large part of the world's energy production is ensured from: coal, natural gas, oil and uranium (Torkashvand et al.,2022). Because of these advantages and certain constraints that characterize them, particularly in terms of cost, the role assigned to

- This is an Open Access article distributed under the terms of the Creative Commons Attribution-Noncommercial 4.0 Unported License, permitting all non-commercial use, distribution, and reproduction in any medium, provided the original work is properly cited.

- Selection and peer-review under responsibility of the Organizing Committee of the Conference

renewable energies, within the framework of the national energy policy, is to meet the energy demand on isolated sites far away. electricity networks. Solar electrification of villages in the deep south, etc.) than in other sectors of the national economy (road marking, water pumping, etc.).

To respond to these concerns, more and more countries are putting in place policies to encourage energy saving, but also the production of energy through other means often qualified as (clean) in reference to the fact that it does not generate carbon dioxide. These means of production are mainly derived from renewable energies, that is to say whose resources are inexhaustible by nature. Among these we can cite wind energy (from the wind), and energy (solar) (Sahraoui et al., 2016; Sahraoui et al., 2021). This entails a study of the sizing parameters of this type of application and their simulation will make it possible to highlight the available control strategies and to evaluate the optimization techniques. For this reason we present a method of optimal dimensioning of the size of the hybrid system of electricity production. To achieve this goal, we have our paper on the simulation of a PV-WIND hybrid system. Integrated in an HVDC Network We practiced on a work plan which helped us a lot to have well determined signals (Sahraoui et al., 2014; Sahraoui et al., 2015).

Photovoltaic-Wind Hybrid System

A hybrid system with renewable energy sources (HSRES) is an electrical system comprising more than one energy source, of which at least one is renewable. For example in this project is a hybrid system (photovoltaic – wind).The hybrid system may include a storage device. From a more global point of view, the energy system of a given country can be considered as a hybrid system. In the figure 1 represents diagram of a hybrid Photovoltaic-wind system.

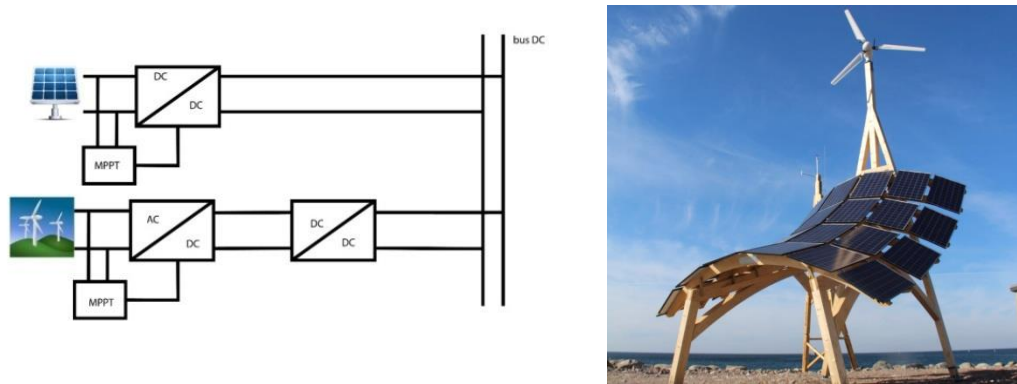

Figure 1. Diagram of a photovoltaic-wind hybrid system

Specifications of a Solar Panel

PV Panel specification	
PV model	1STH-215-P
Short circuit current (Isc)	7.84 A
Open circuit voltage (Voc)	36.3 V
Maximum Voltage (Vmpp)	29 V
Maximum current (Impp)	7.35 A
Maximum power (Pmpp)	213.15 W
Number of cells in series (Ns)	60
Temperature coefficient of Isc	-0.36099%/°C
Temperature coefficient Voc	0.102%/°C
Diode ideality factor (A)	0.98117
Series resistance (Rs)	0.39383Ω
Shunt resistance (Rsh)	313.3991Ω

Figure 2. Electrical characteristics of the model solar panel (1Soltech 1STH-215-P Polycrystalline Module)

We will study in this work the model of a following panel: Soltech 1STH-215-P PV Panel
 Features of this panel: The electrical characteristics of this photovoltaic panel are given by the Figure 2.

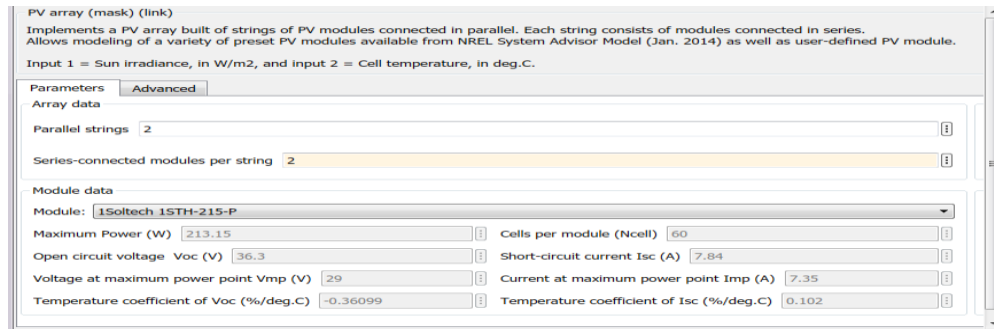

Figure 3. Electrical characteristics of solar panel

The representative diagram of the mathematical model of the photovoltaic module under Matlab-silink is given by (Figure.III.5):

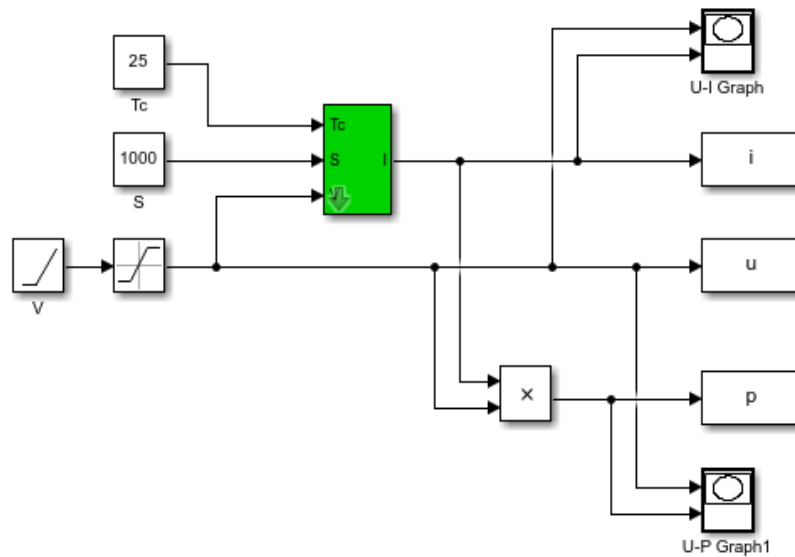

Figure 4. PV simulation diagram of PV

The simulation of a PV generator under standard conditions ($E=1000 \text{ w/m}^2$ and $T=25^\circ$), gave the curves presented in (figure 5). It is found that the set of characteristics P_{PV} and I_{PV} are strongly nonlinear and depends on the solar irradiation and the temperature of the photovoltaic panels.

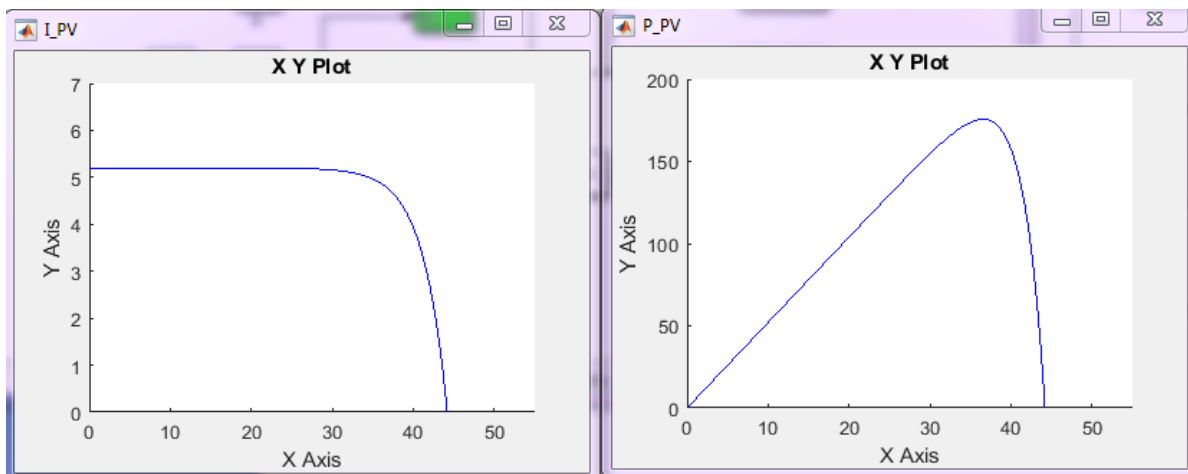

Figure 5. influence of radiation on the I_{PV} and P_{PV} characteristics (1000W/m^2 and 25°).

Simulation result of the generator (GPV) with variable illumination and temperature;
To observe the influence of external conditions of light and temperature

(E,T) on the characteristic (I-V) (P-V), we have adopted the following methods:

To visualize the influence of irradiation, the temperature a ($T=25^\circ$) is fixed and the illumination is varied within a sufficient range.

We vary the irradiation (E) [1000 500 100] (W/m^2), the characteristic ($P=f(V)$) and the characteristic ($I=f(V)$) are given by Figure 6 . According to these results, the current is directly proportional to the radiation, unlike the voltage which varies very little according to the illumination

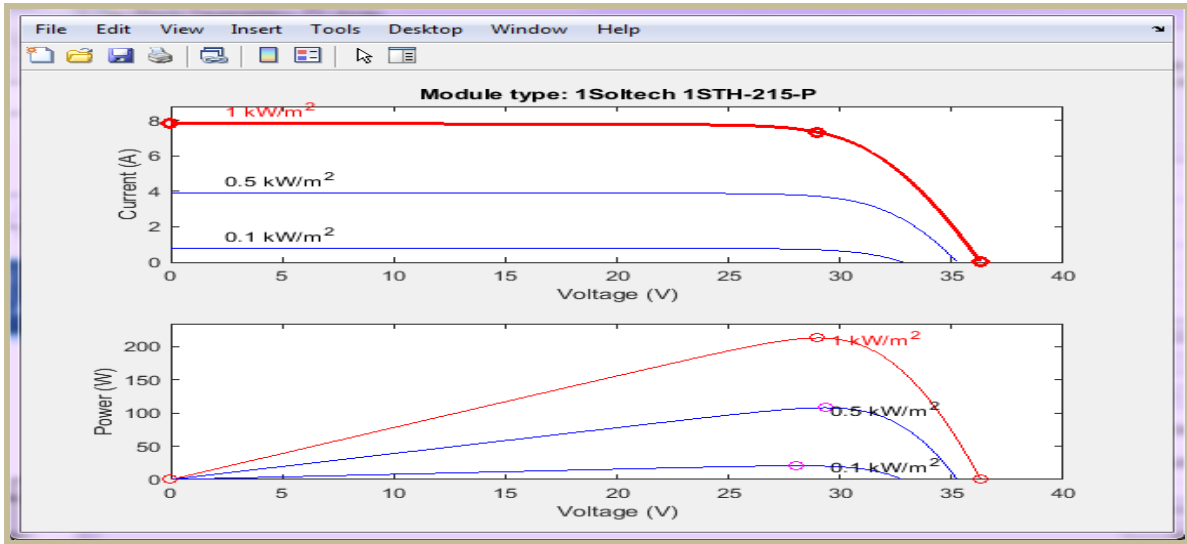

Figure 6. Influence of irradiation variation on characteristics (I-V) and (P_V)

Wind System Simulation with PMSG

Figure 7 represents the mechanical power as a function of the rotational frequency of the rotor for different wind speeds. Figure 8 represents Power coefficient as a function of specific speed. Figure 9 depicts the MPPT Block
Figure 10 represents the final wind turbine simulation with MSG

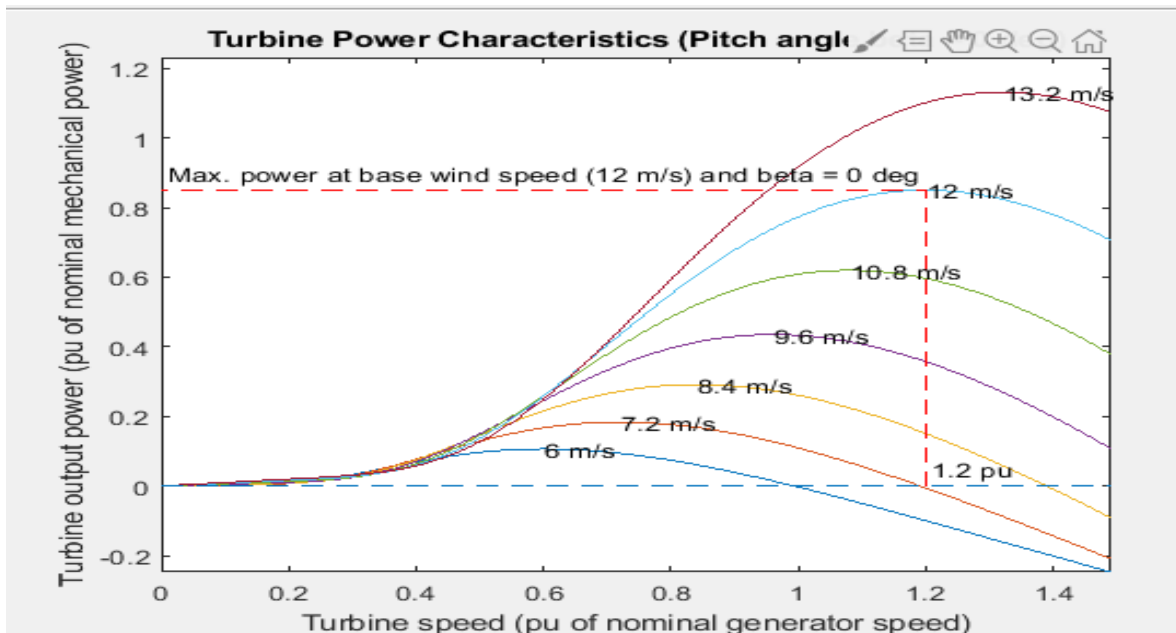

Figure 7. Power variation curves from speed.

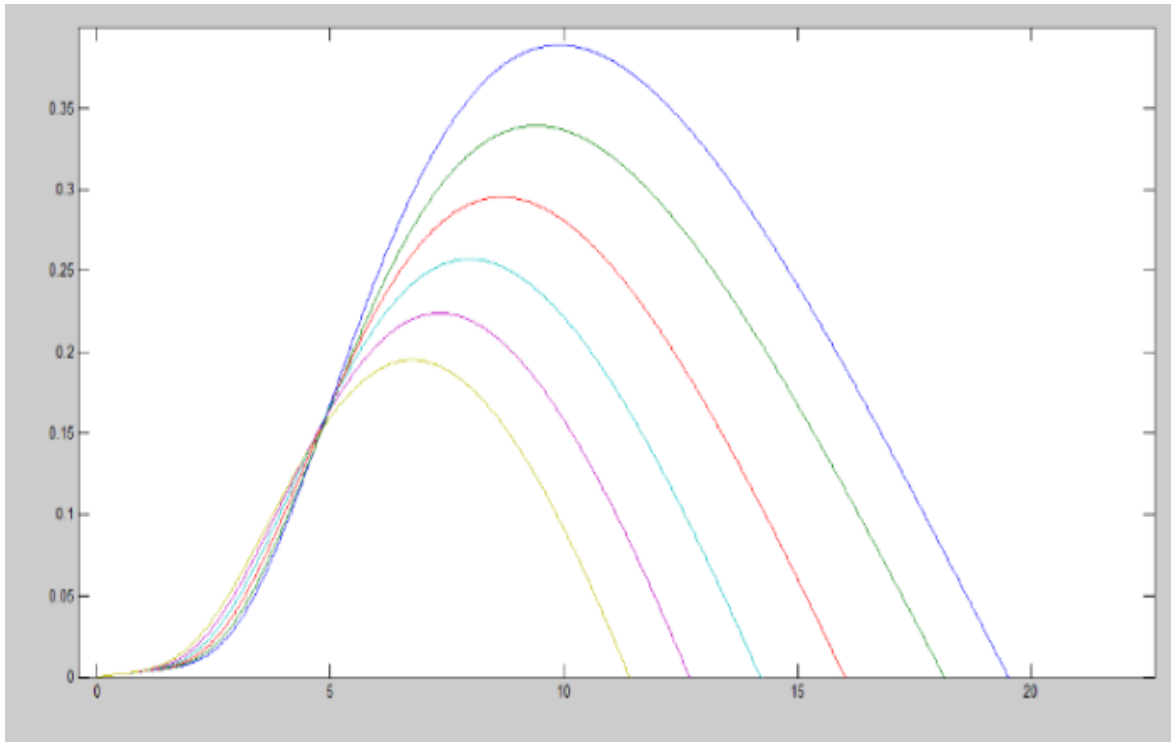
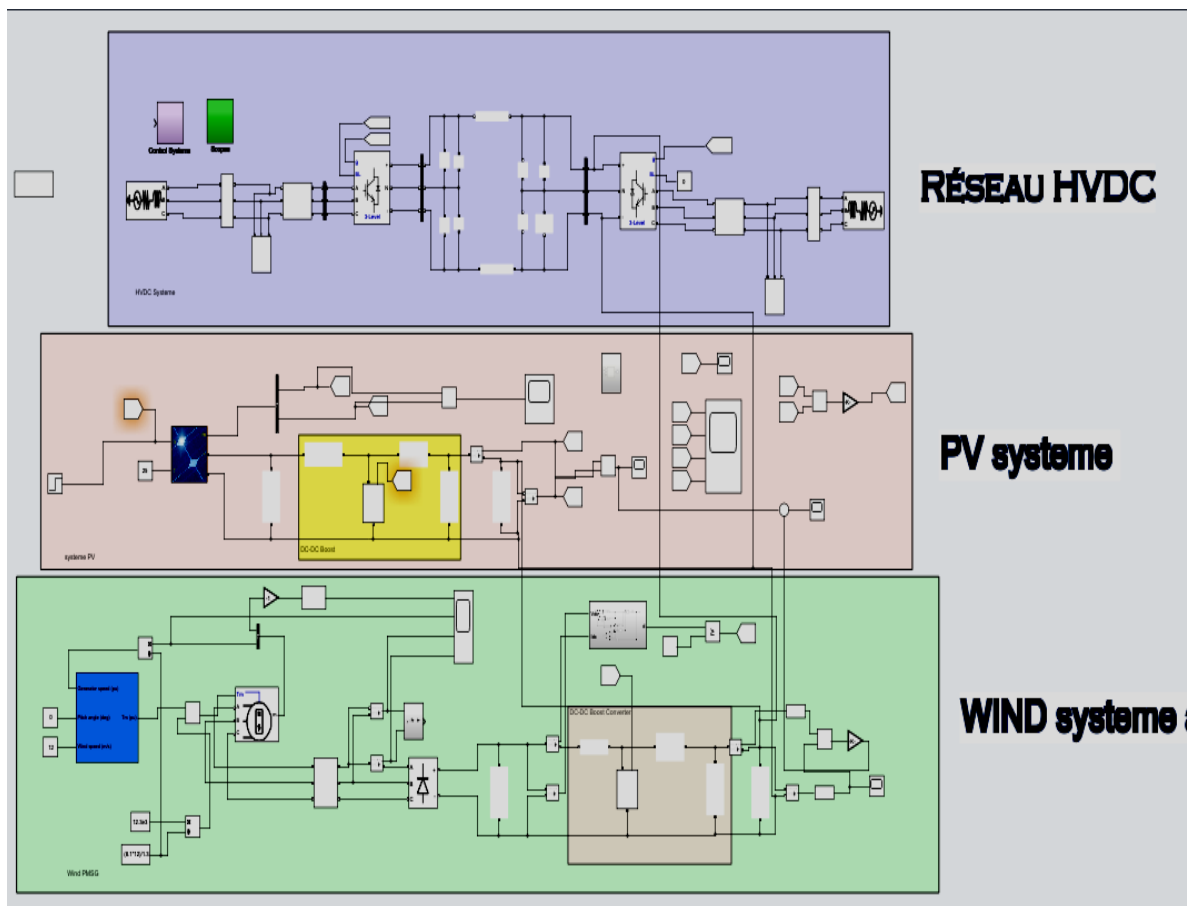

Figure 8. Curve of variation of Cp from lamda



After having approached the simulation of solar system and wind system integrated in HVDC network, we obtain the following curves:

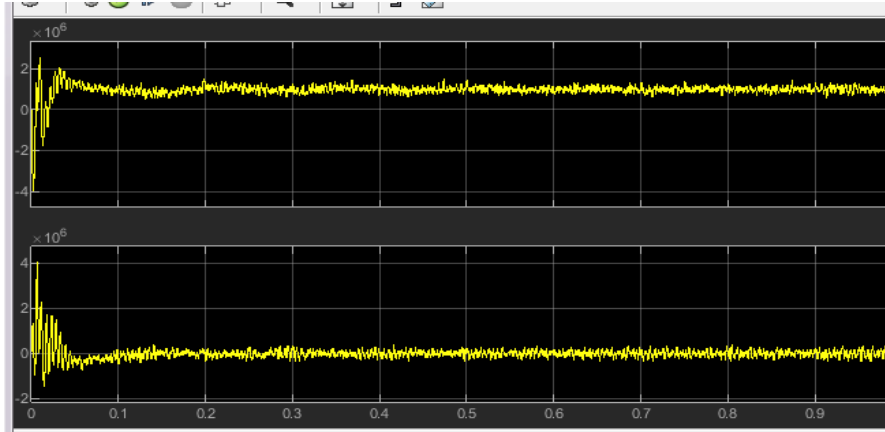

Figure 9. P and Q power curve at HVDC network output

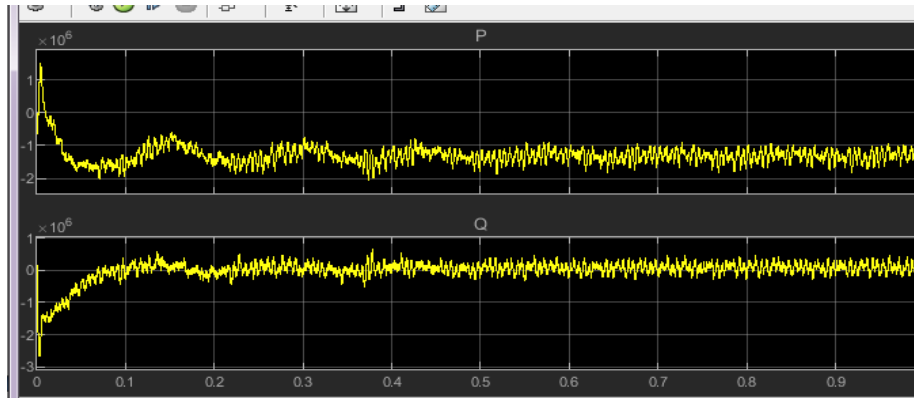

Figure 10. Curve of P and Q Grid

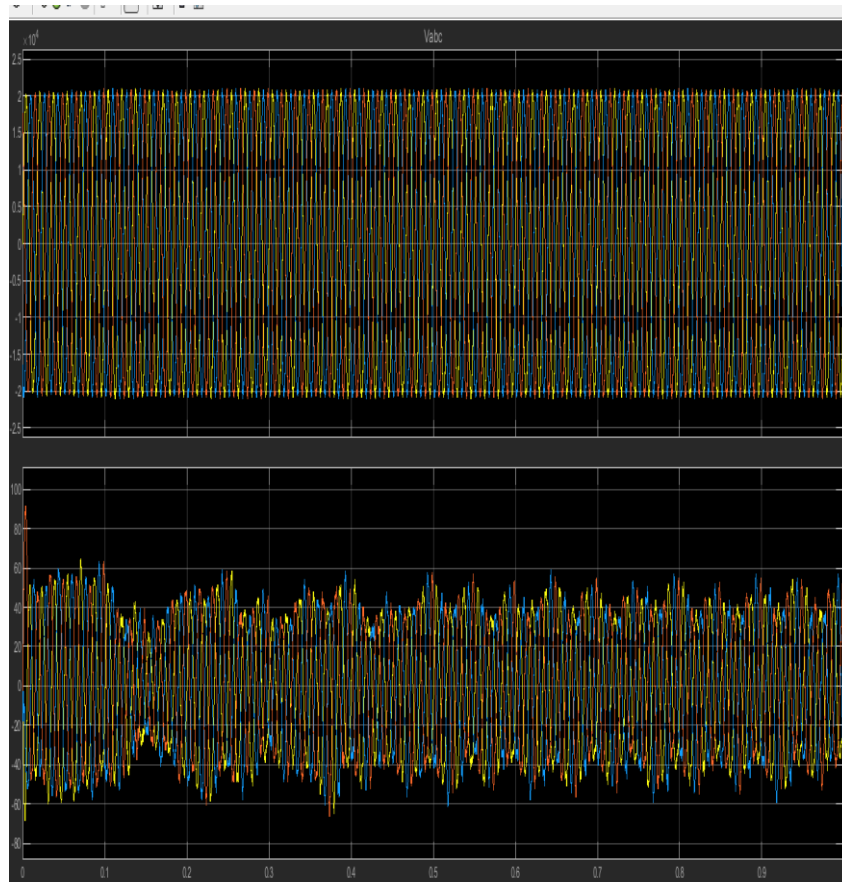

Figure 11. Vabc voltage curve

Voltage at the DC Bus of PV and Wind Power

After having approached the simulation of solar system and wind system integrated in HVDC network, we obtain the following curves of the DC BUS voltage V_{out} of PV and wind with PMSG:

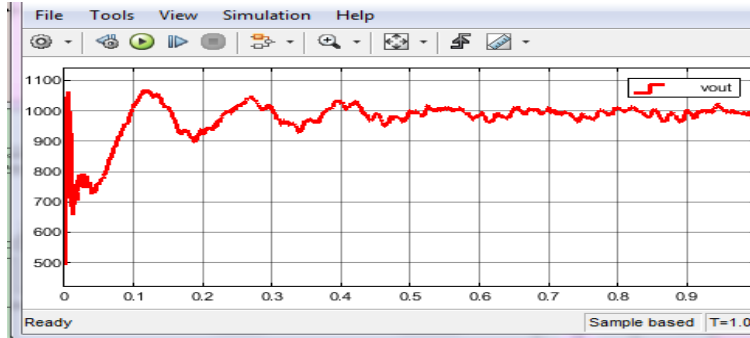

Figure 12. Courbe of tension Bus DC of PV

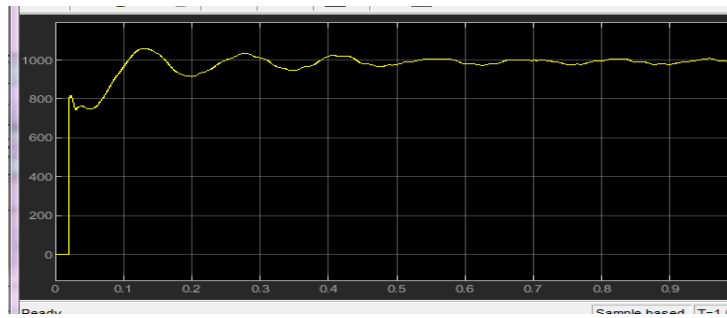

Figure 13. Courbe of tension Bus DC wind

After having approached the simulation of solar system and wind system integrated in HVDC network we obtain final curve of voltage of BUS DC V_{dc} :

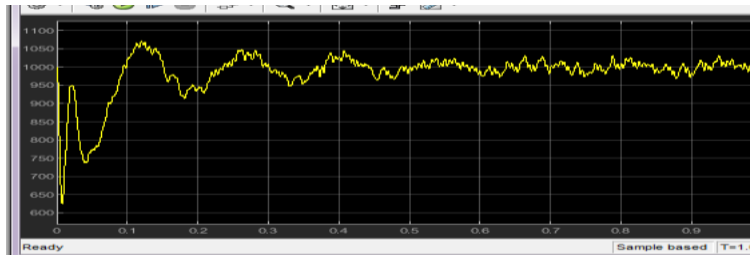

Figure 14. Courbe of tension Bus DC HVDC

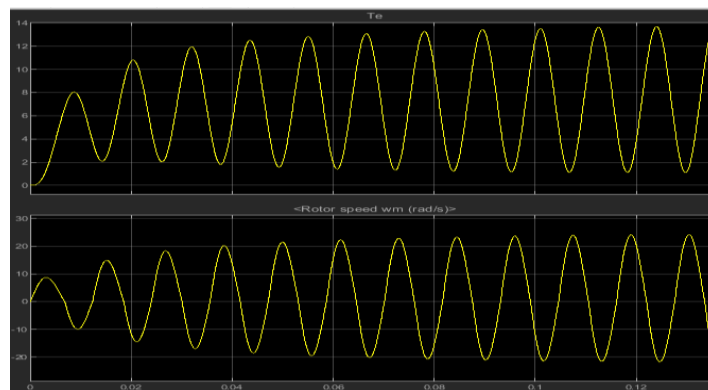

Figure 15. Courbe electromagnetic T_e avec W_m

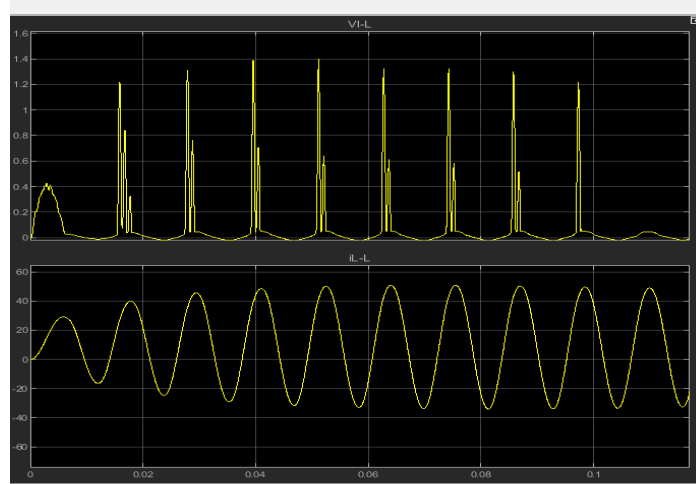

Figure 16. Course of tension and courant of wind

Conclusion

In this paper, we have presented a study and a sizing of a hybrid PV / wind system with the method of the monthly energy produced by the system Per unit area for the purpose of having a good reliable configuration with a minimum cost, We will simulate a hybrid solar and wind system and notice the simulation results And the HVDC network simulation and we notice the results of this simulation In the end will integrate the solar and wind system into this network.

Scientific Ethics Declaration

The authors declare that the scientific ethical and legal responsibility of this article published in EPSTEM journal belongs to the authors.

Acknowledgements or Notes

* This article was presented as an oral presentation at the International Conference on Technology, Engineering and Science (www.icontes.net) held in Antalya/Turkey on November 16-19, 2023.

References

- Alnejaili, T., Drid, S., Mehdi, D., Chrifi-Alaoui, L., & Sahraoui, H. (2015). Sliding mode control of a multi-source renewable power system. *The 3rd International Conference Control, Engineering & Information Technology (CEIT'2015)*. Tlemcen, Algeria. Retrieved from <http://lat.univtlemcen.dz/ceit2015/index.php>.
- Boutabba, T., Sahraoui, H., Bechka, M. L., Drid, S., & Chrifi-Alaoui, L. (2020). A comparative study of MPPT techniques for standalone hybrid PV-wind with power management. *Lecture Notes in Electrical Engineering*, 93–108.
- Sahraoui, H., Chrifi-Alaoui, L., Drid, S., & Bussy, P. (2016). Second order sliding mode control of DC-DC converter used in the photovoltaic system according an adaptive MPPT. *International Journal of Renewable Energy Research*, 6(2), 375-383.
- Sahraoui H., Mellah H., Drid S., & Chrifi-Alaoui L. (2021). Adaptive maximum power point tracking using neural networks for a photovoltaic systems according grid. *Electrical Engineering & Electromechanics*, 5, 57-66.
- Sahraoui, H., Drid, S., Chrifi-Alaoui, L., & Idriss, B. (2014). Modeling and control of the DC-DC converters. *International Conference on Industrial Engineering & Manufacturing ICIEM'14*, 11-13 Mai, Batna, Algeria. Retrieved from <http://iciem2014.univbatna.dz/>.
- Sahraoui, H., Drid, S., Chrifi-Alaoui, L. (2014). Robust control of the second order sliding mode controller with dc boost converter improved for the photovoltaic Systems DC-DC. *15th International Conference on*

Sciences and Techniques of Automatic control & computer engineering. STA'2014.IEEE. Retrieved from www.sta-tn.com.

- Sahraoui, H., Drid, S., Chrifi-Alaoui, L., & Hamzaoui, M. (2015). Voltage control of DC-DC buck converter using second order sliding mode control. *The 3rd International Conference on Control, Engineering & Information Technology (CEIT'2015)*. IEEE. Retrieved from <http://lat.univtlemcen.dz/ceit2015/index.php>.
- Sahraoui, H., Chrifi-Alaoui, L., Ouriagli, M., Drid, S., & Mehdi, D. (2018). "he dynamic control and optimal management of the energy in the case of a territory isolated in Batna city. *7th International Conference on Systems and Control (ICSC)* . IEEE.
- Torkashvand, M., Hasan-Zadeh, A., & Torkashvand, A. (2022). Mini review on importance, application, advantages and disadvantages of biofuels. *J. Mater. Environ. Sci.*, 13(6), 612-630.

Author Information

Hamza Sahraoui

Electrical Engineering Department, Hassiba Benbouali University of Chlef, B.P 78C, Ouled Fares Chlef 02180, Chlef, Algeria, Research Laboratory LSPIE, Electrical Engineering Department, University of Batna 2
Contact e-mail: hamzasahraoui@gmail.com

Hacene Mellah

Electrical Engineering Department, University Akli Mouhand Oulhadj-Bouira, Rue Drissi Yahia Bouira, 10000, Algeria

Amar Maafa

Electrical Engineering Department, University Akli Mouhand Oulhadj-Bouira, Rue Drissi Yahia Bouira, 10000, Algeria

Abdelghani Yahiou

Electrical Engineering Department, University Akli Mouhand Oulhadj-Bouira, Rue Drissi Yahia Bouira, 10000, Algeria

Saïd Drid

Research Laboratory LSPIE, Electrical Engineering Department, University of Batna 2, 53, Route de Constantine, Fésdis, Batna 05078, Algeria

L. Chrifi-Alaoui

Laboratoire des Technologies Innovantes (LTI), University of Picardie Jules Verne, IUT de l'Aisne, 13 Avenue François Mitterrand 02880 Cuffies-Soissons, France

To cite this article:

Sahraoui, H., Mellah, H., Maafa, A., Yahiou, A., Drid, S., & Chrifi-Alaoui, L.(2023). Management and control of hybrid system WIND-PV systems integrated to the VSC-HVDC grid. *The Eurasia Proceedings of Science, Technology, Engineering & Mathematics (EPSTEM)*, 26, 430-438.